

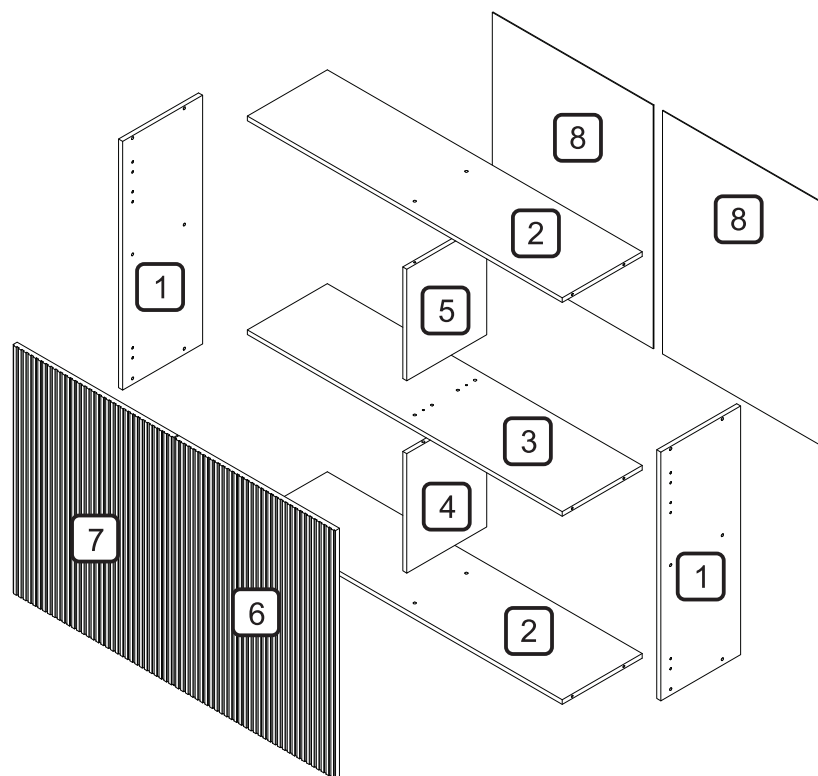

A marca da gestão florestal responsável
FSC® C168299

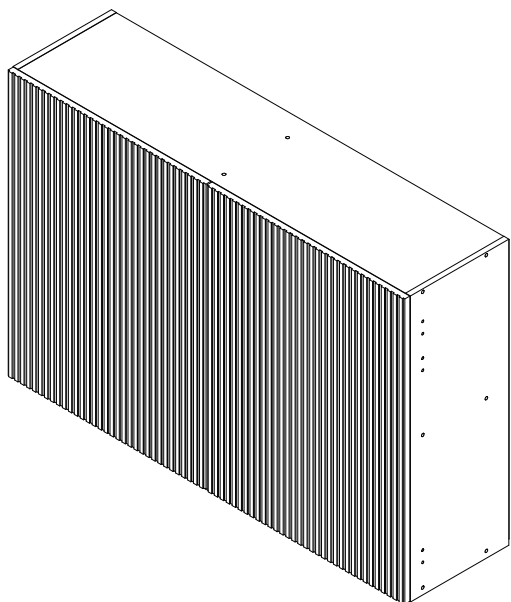





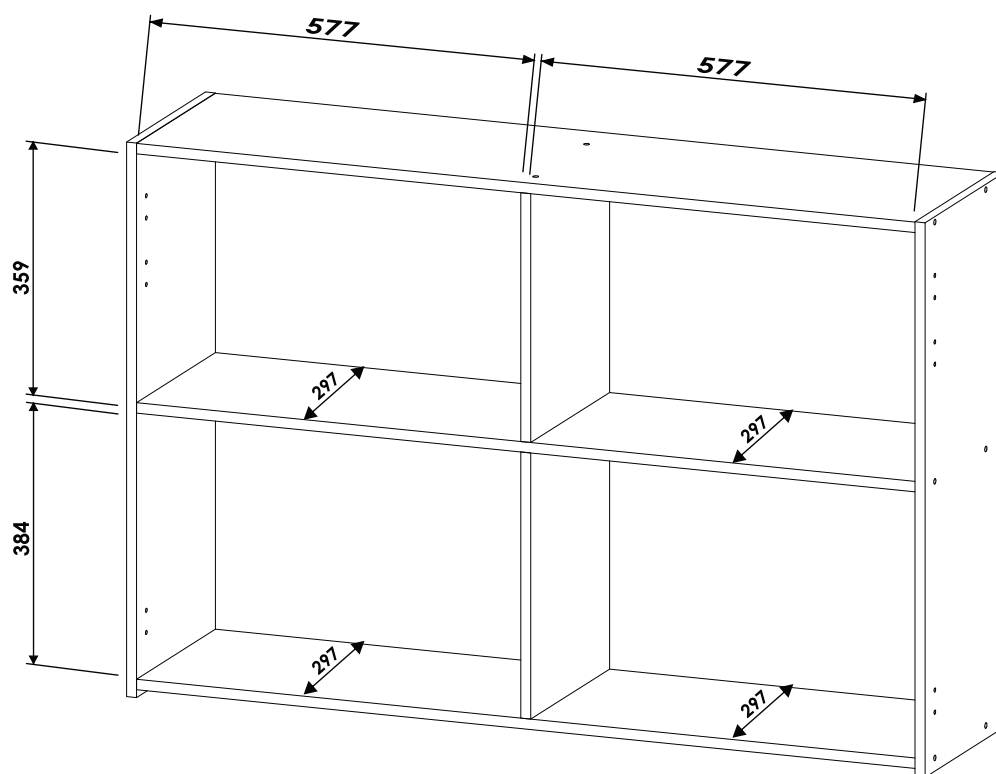
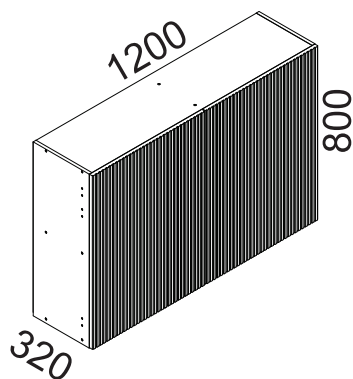

DIMENSÕES DOS ESPAÇOS INTERNOS (MEDIDAS EM MILÍMETROS)

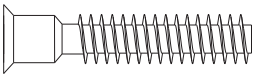
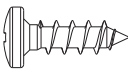
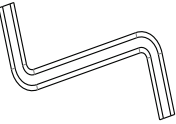
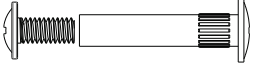
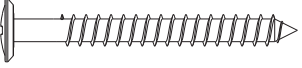
DIMENSÕES MÁXIMAS DO PRODUTO MONTADO

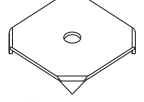
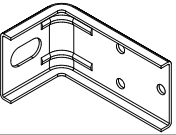
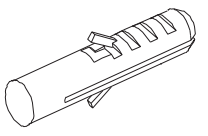
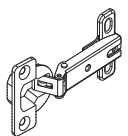

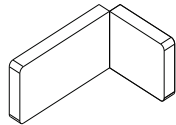
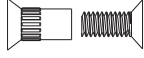
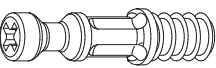
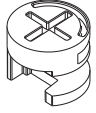
CÓDIGO	DESCRIÇÃO	QTDE	COMP	LARG	ESP
1	LATERAL DIREITA/ESQUERDA	2	800	297	15
2	TAMPO/BASE	2	1,170	297	15
3	PRATELEIRA	1	1,170	297	15
4	DIVISÃO INFERIOR	1	359	297	15
5	DIVISÃO SUPERIOR	1	384	297	15
6	PORTA DIREITA MONTADA	1	798	597	18
7	PORTA ESQUERDA MONTADA	1	798	597	18
8	FUNDO TRASEIRO	2	785	597	2.5

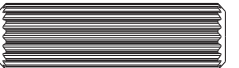
CÓDIGO/DESCRIÇÃO	QUANTIDADE	CÓDIGO/DESCRIÇÃO	QUANTIDADE
A  PARAFUSO 7x40mm CABEÇA CHATA	18	B  PARAFUSO 4x14mm CABEÇA PANELA	24
C  CHAVE ZETA	1	D  PARAFUSO UNIÃO DE MÓDULOS 28MM	3
E  PARAFUSO 5x50mm CABEÇA FLANGEADA	4	F  TAPA FURO ADESIVO 12mm	26
G  PREGO 10x10 COM CABEÇA	56	H  FIXADOR FUNDO TRASEIRO METÁLICO	10
I CANTONEIRA METÁLICA PARA FIXAÇÃO NA PAREDE 	4	J BUCHA DE PAREDE DE 8mm 	4
K DOBRADIÇA SLOW MOTION C/ CALÇO RÉTA CANECO 35mm 	6	L BATENTE DE SILICONE 	4
M CAPA PLÁSTICA PARA CANTONEIRA 	4	N  PARAFUSO UNIÃO DE MÓDULOS 17MM	13
O PARAFUSO MINIFIX 	3	P TAMBOR MINIFIX 	3
Q TAMPA MINIFIX 	2	R  CAVILHA 8x30mm	2

Ferramentas para montagem e instalação



PARAFUSADEIRA



FURADEIRA



NÍVEL



TRENA



MARTELO



CHAVE PHILIPS E FENDA

Montagem



Instalação

